

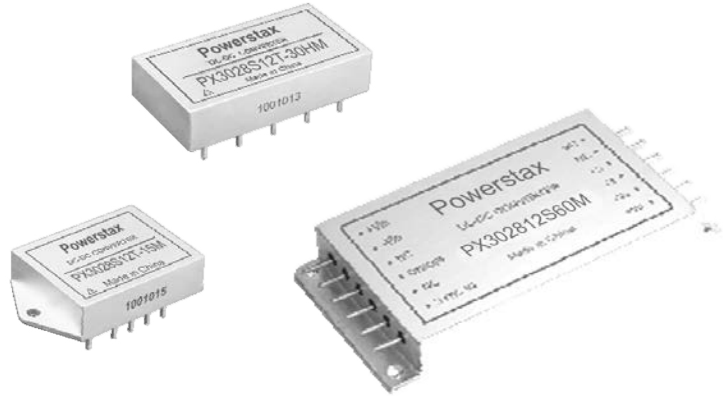

- High reliability, small size
- -55 to +105°C operation
- 16-40VDC Input Range
- Fixed Frequency
- Inhibit
- Short circuit protection
- Hermetic DIP Package



PX30 SERIES

POWER SUPPLY DESIGN EXCELLENCE

The PX30 Series of high frequency DC-DC converters offers single, dual and triple output models from 12 watts to 65 watts output power over the full temperature range of -55 to +105°C with up to 84% efficiency. The small size, low height, and hermetically sealed metal enclosures with 3 quality

levels make these units ideal for use in military, aerospace and other high reliability applications. They are available with standard screening, and fully compliant class E/M screening.

The PXH Series offers a form, fit, function alternative to the Interpoint MHF, MTR & MFL Series.

	STANDARD MODEL	OUTPUT VOLTAGE	OUTPUT CURRENT	OUTPUT POWER	EFFICIENCY MIN. / TYP.	INPUT VOLTAGE	INPUT CURRENT
15W Series	PX302805S-12xy	5.0V	2.40A	12W	73% / 78%	28VDC	550mA
	PX30285R2S-12xy	5.2V	2.30A	12W	73% / 78%		550mA
	PX302812S-15xy	12.0V	1.25A	15W	77% / 82%		654mA
	PX302815S-15xy	15.0V	1.00A	15W	78% / 83%		645mA
	PX302805D-15xy	±5.0V	±1.5A	15W	76% / 80%		670mA
	PX302812D-15xy	±12.0V	±0.625A	15W	80% / 84%		670mA
	PX302815D-15xy	±15.0V	±0.50A	15W	80% / 84%		670mA
	PX3028512T-15xy	5.0V, ±12V	1.50A, ±0.32A	15W	75% / 79%		678mA
	PX3028512T-15xy	5.0V, ±15V	1.50A, ±0.25A	15W	75% / 79%		678mA
30W Series	PX3028512T-15xy	5.0V, ±12V	4.00A, ±0.42A	30W	75% / 79%	28VDC	1350mA
	PX3028512T-15xy	5.0V, ±15V	4.00A, ±0.33A	30W	75% / 79%		1350mA
65W Series	PX302805S-50y	5.0V	10.00A	50W	74% / 78%	28VDC	2290mA
	PX302812S-60y	12.0V	5.00A	60W	79% / 83%		2580mA
	PX302815S-65y	15.0V	4.33A	65W	78% / 82%		2830mA
	PX302828S-65y	28.0V	2.32A	65W	79% / 83%		2780mA
	PX302805D-50y	±5.0V	±5.00A	50W	76% / 80%		2250mA
	PX302812D-60y	±12.0V	±2.50A	60W	79% / 83%		2600mA
	PX302815D-65y	±15.0V	±2.17A	65W	78% / 82%		2830mA

ORDERING GUIDE

PX3028 uRu v - ww xy

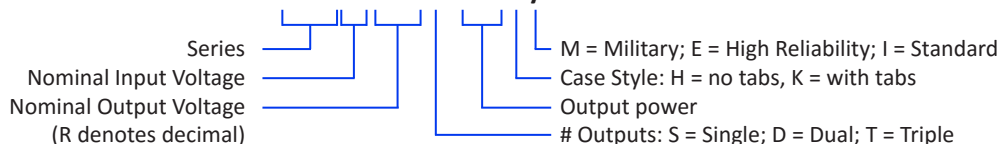



	15W Series	30W Series	65W Series
INPUT SPECIFICATIONS			
Voltage Range	16-40VDC		
Voltage Transient	50V / 50ms		
Current - No Load	singles/dual - 30mA max. triples - 100mA max.	100mA max.	100mA max.
Full Load Inhibited	see model table singles/duals - 8mA max. triples - 20mA max.	see model table 50mA max.	see model table 20mA max.
Ripple Current	100mA pk-pk max.: 28Vin, Full Load, 20MHz		

OUTPUT SPECIFICATIONS¹			
Voltage Setting Tolerance	Vnom. $\leq \pm 2.0\%$		
Maximum Current	see model table: Vin 16-40V		
Maximum Power	see model table: Vin 16-40V		
Line Reg. - 16-40Vin Min. - Max. Tc	$\leq 50\text{mV}$ $\leq 50\text{mV}$	$\leq 50\text{mV}$ $\leq 50\text{mV}$	$\leq 80\text{mV}$ $\leq 120\text{mV}$
Load Reg. - NL - FL Min. - Max. Tc	$\leq 50\text{mV}$ $\leq 50\text{mV}$	$\leq 50\text{mV}$ $\leq 50\text{mV}$	$\leq 120\text{mV max.}$ $\leq 180\text{mV max.}$
Cross Reg. - 20% to 80% FL 10% to 50% FL	5% max. 3% max.	3% max. 3% max.	8% max.: -Vo ² 6% max.: -Vo ³
Efficiency	see model table: 28Vin, Full Load		
Ripple ⁴ - 20MHz Min. - Max. Tc	$\leq 80\text{mV}$ $\leq 100\text{mV}$	$\leq 80\text{mV}$ $\leq 120\text{mV}$	$\leq 50\text{mV}$ $\leq 120\text{mV}$
Step Load ⁵ - Deviation Recovery Time	$\leq \pm 400\text{mV}$ $\leq 300\mu\text{s}$	$\leq \pm 500\text{mV}$ $\leq 300\mu\text{s}$	$\leq \pm 1200\text{mV}$ $\leq 500\mu\text{s}$
Step Line ⁶ - Deviation Recovery Time	$\leq \pm 300\text{mV}$ $\leq 300\mu\text{s}$		$\leq \pm 600\text{mV}$ $\leq 500\mu\text{s}$
Start-Up - Delay Overshoot	$\leq 20\text{ms}$ $\leq 500\text{mV}$	$\leq 20\text{ms}$ $\leq 100\text{mV}$	$\leq 50\text{ms}$ $\leq 100\text{mV FL, } \leq 200\text{mV NL}$

1. Unless otherwise specified, ambient temperature is +25°C, input voltage is 28V, output full load.
2. -Pout 20%, +Pout 20% to 80%.
3. -Pout 10%, +Pout 10% to 50%.
4. Using tip and barrel measurement.
5. 50%-100%-50% step change. Recovery time measured from application of transient to point at which Vo <1% of final value, transition time >25μs.
6. 16V-40V-16V step change. Recovery time measured from application of transient to point at which Vo <1% of final value, transition time >25μs.

OTHER SPECIFICATIONS			
Switching Frequency	500kHz typical 900kHz typical (triples)	900kHz typical	720kHz typical
Operating Temp. Range	Grade M: -55°C to +105°C Grades E & I: -40°C to +85°C		
Storage Temp. Range	-55°C to +125°C		
Insulation Resistance	500VDC, $\geq 100\text{M}\Omega$: Input-Output, Input-Case, Output-Case		
Pin Solder Temperature	300°C (10s)		
Isolation Capacitance	2200pF		4700pF
MTBF, Ground Fixed	781,000 hours: singles 731,000 hours: duals 497,000 hours: triples	435,000 hours	550,000 hours



TYPICAL PERFORMANCE CURVES

15W SINGLE (PX302805S-12)

Output Ripple

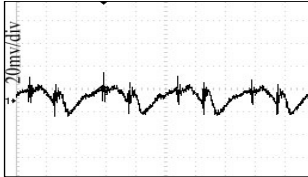

Start-Up

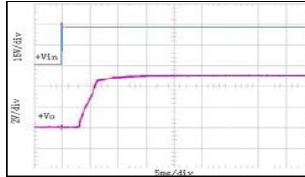

Step Load Response

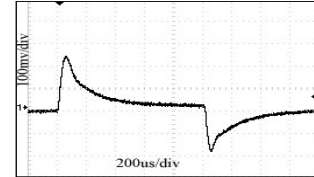

15W DUAL (PX302812D-15)

Output Ripple

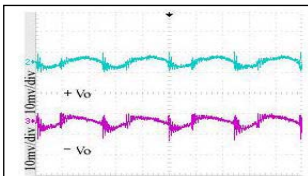

Start-Up

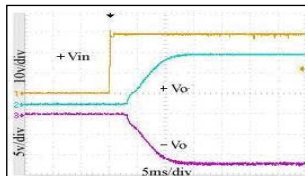

Step Load Response

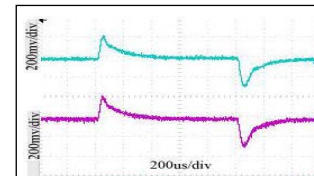

15W TRIPLE (PX3028512T-15)

Output Ripple

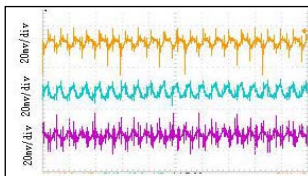

Start-Up

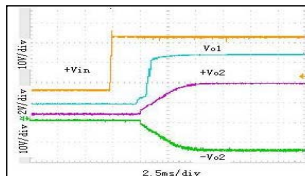

Step Load Response

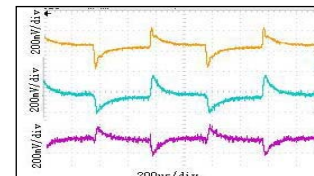

30W TRIPLE (PX3028152T-30)

Output Ripple

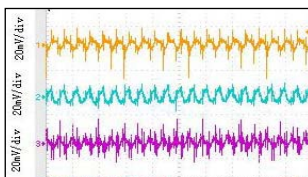

Start-Up

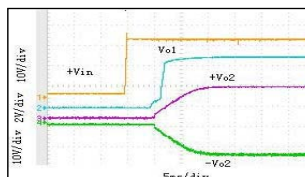

Step Load Response

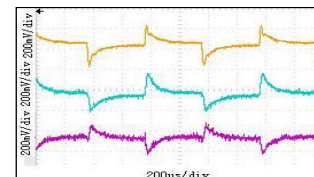

65W SINGLE (PX302805S-50)

Output Ripple

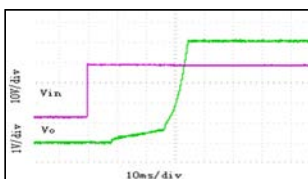

Start-Up

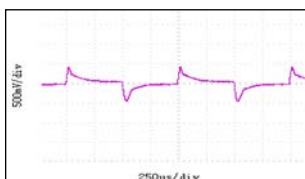

Step Load Response

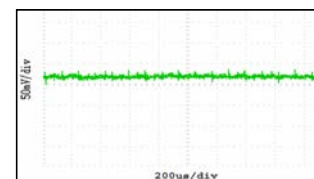

65W DUAL (PX302812D-60)

Output Ripple

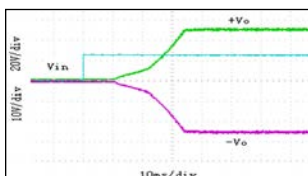

Start-Up

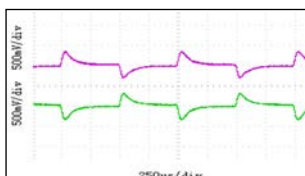

Step Load Response

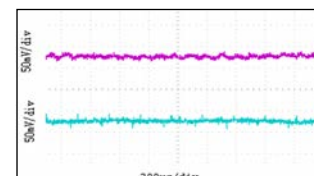

PX30 SERIES



MECHANICALS - 15W

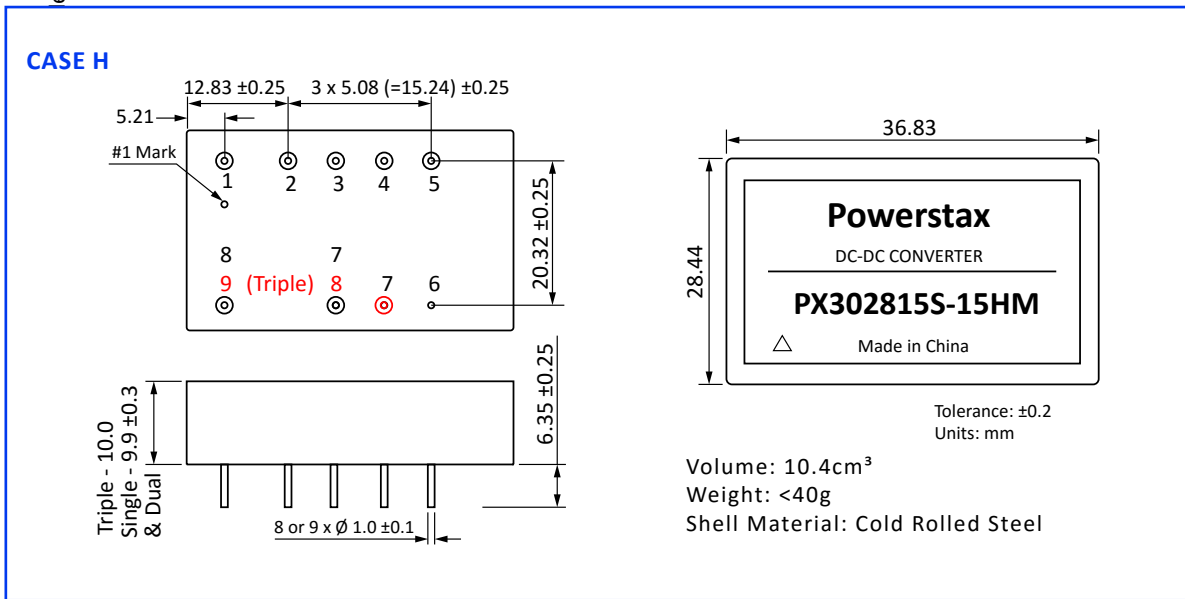
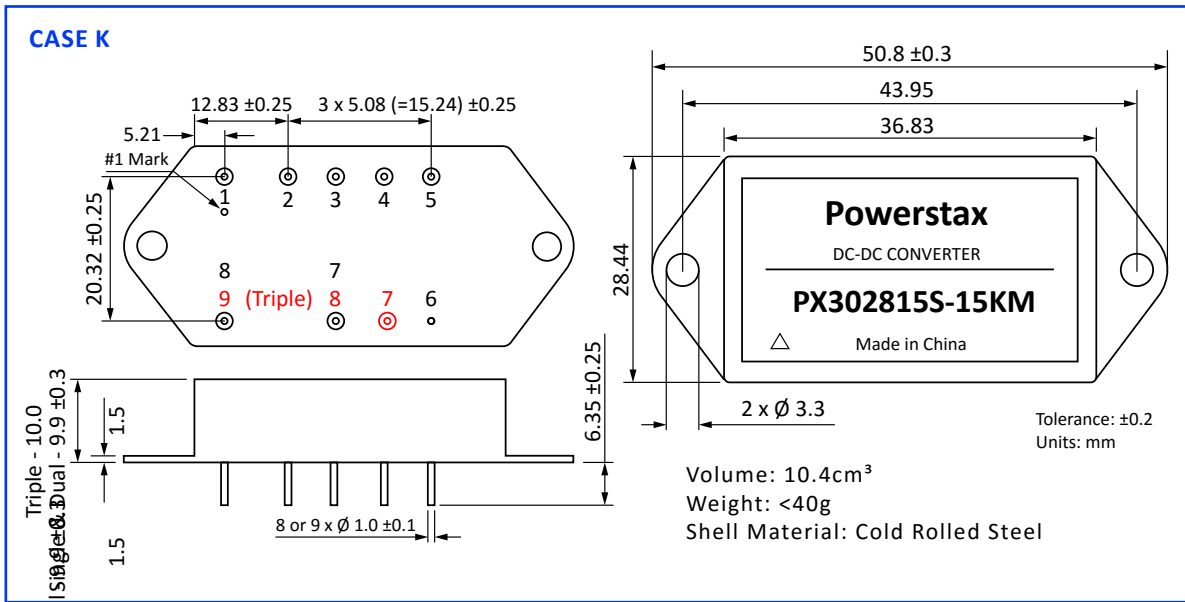

Connections							
Pin	Single Output	Dual Output	Triple Output	Pin	Single Output	Dual Output	Triple Output
1	Inhibit	Inhibit	Inhibit	5	Sync	Sync	Output 2 -Ve
2	n/c	Positive Output	Output 1 +Ve	6	Case Gnd	Case Gnd	Sync
3	Output Common	Output Common	Output Common	7	Input Common	Input Common	Case Gnd
4	Positive Output	Negative Output	Output 2 +Ve	8	Input +Ve	Input +Ve	Input Common
				9	-	-	Input +Ve

PX30 SERIES



MECHANICALS - 30W

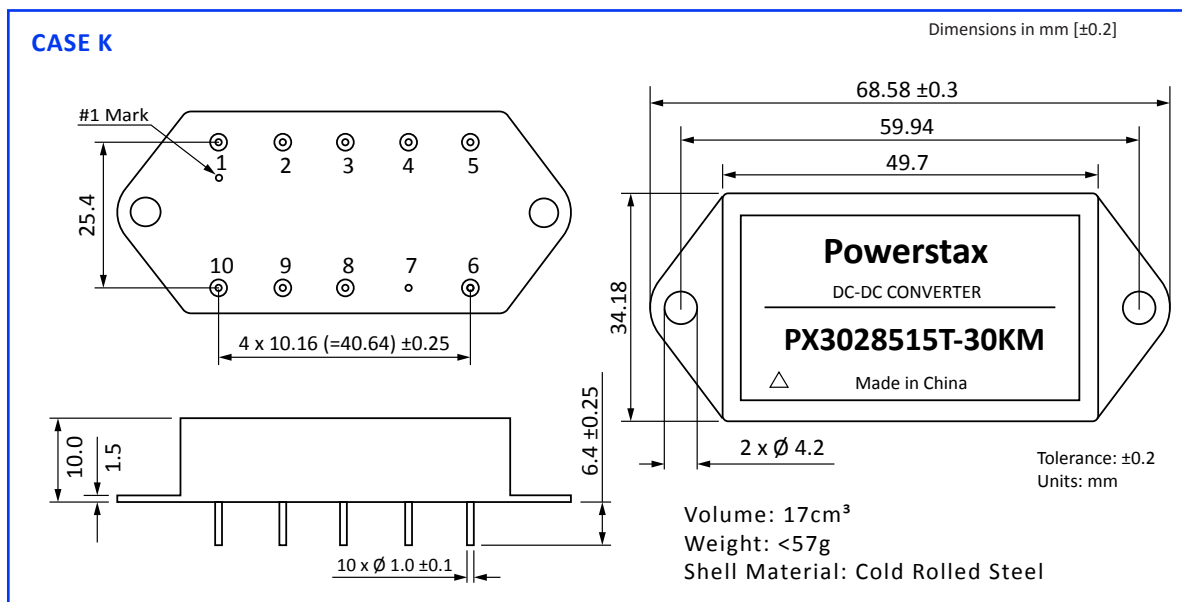

PX30 SERIES

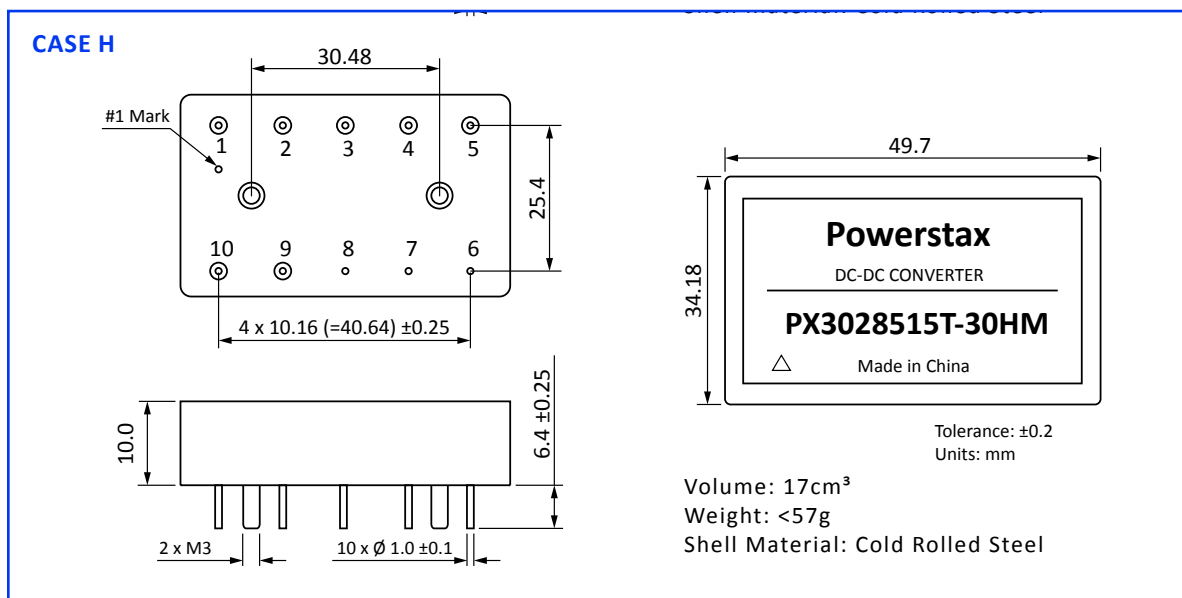

Connections			
Pin		Pin	
1	Input Positive	6	Case Gnd
2	Output 1 +Ve	7	Case Gnd
3	Output Common	8	Inhibit
4	Output 2 -Ve	9	Sync
5	Output 2 +Ve	10	Input Common



MECHANICALS - 65W

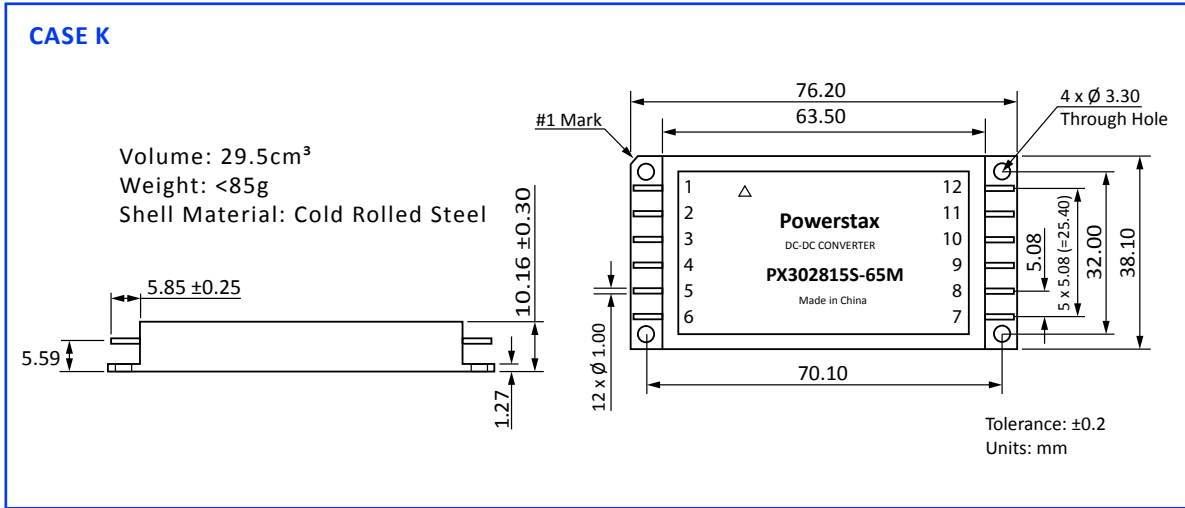

PX30 SERIES

Connections					
Pin	Single Output	Dual Output	Pin	Single Output	Dual Output
1	Input +Ve	Input +Ve	7	Positive Output	Positive Output
2	Input Common	Input Common	8	Output Common	Output Common
3	n/c	n/c	9	Sense Return	Negative Output
4	Inhibit	Inhibit	10	Sense Positive	n/c
5	n/c	n/c	11	n/c	n/c
6	Sync	Sync	12	n/c	n/c

ENVIRONMENTAL SCREENING

TEST OR INSPECTION		CLASS I	CLASS E	CLASS M
Internal Inspection	MIL-STD-883 Method 2017	✓	✓	✓
High Temperature Storage	125°C, 48 hours	✗	✗	✓
Temperature Cycling	MIL-STD-883 Method 1010 Condition B, (x10)	✗	✓	✓
Constant Acceleration	MIL-STD-883 Method 2001, 3000G, Y1, 1Min.	✗	✓	✓
Intermediate Electrical Test	Tc : +25°C	✗	✓	✓
Burn-in	Tc: +105°C, ≥160H	✗	✗	✓
	Tc: +85°C, ≥96H	✗	✓	✗
	Tc: +85°C, ≥48H	✓	✗	✗
Final Electrical Test	Tc : -55°C, +25°C, +105°C	✗	✗	✓
	Tc : -40°C, +25°C, +85°C	✓	✓	✗
Seal	MIL-STD-883 Method 1014 Condition A1	✗	✓	✓
	MIL-STD-883 Method 1014 Condition A1	✓	✓	✓
External Inspection	MIL-STD-883 Method 2009	✓	✓	✓

BLOCK DIAGRAM

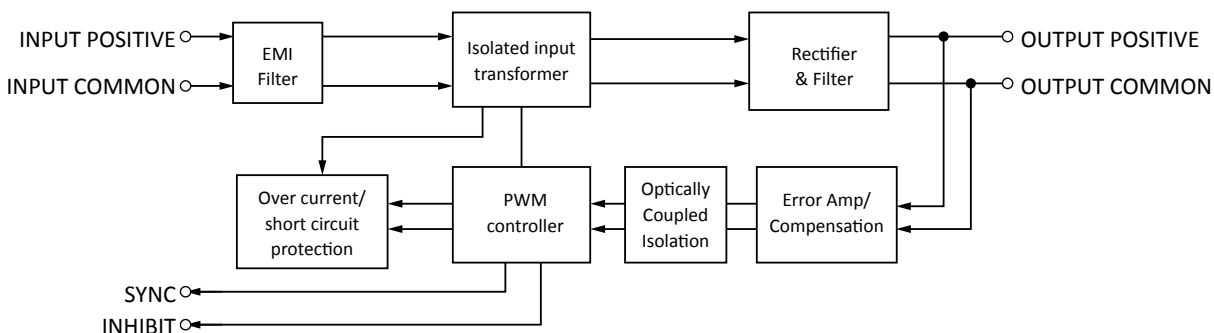

APPLICATION NOTES

DC-DC Converter Typical Connection For Single Output Unit Shown As Below

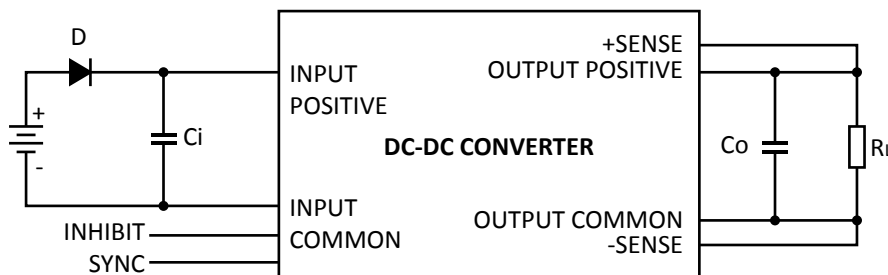

Note: Sense connections are available only on 65W single output models.

Inhibit Function

The INHIBIT pin can be used as an external shut down for applications requiring remote on/off control.

- A logic pulled low (0 to 0.3V) disables the converter.
- No connection enables the converter.

Over Current/Short Circuit Protection

The PX30 series of DC-DC converters has over current/short circuit protection. When operating under a load fault condition, the converter will automatically activate the over current/short circuit protection. It will automatically recover when the fault is removed.

Caution: The duration of the over current/short circuit must be less than 10s, and the case temperature lower than 105°C, Otherwise, the module may be damaged.

Ripple Voltage Suppress

Use a tip and barrel measurement to test the output ripple voltage, with a maximum bandwidth of 20MHz.

If the output voltage ripple required cannot be met in a particular application, it can be improved by adding capacitors between the output positive/negative and common pins. The recommended capacitors are film capacitors or ceramic capacitors. Larger capacitance can be accomplished by connecting several capacitors in parallel.



Synchronization

A synchronization feature is included in all version of the PX30 Series. This allows the user to match the switching frequency of the converter to the frequency of the system clock.

The external synchronization feature allows the user to adjust the nominal frequency within the range shown in the following, at a level from 4.5V to 5.5V. The sync pulse width should be between 15ns and 150ns.

- 15W Single & Dual Output - 500 to 550kHz
- 15W Triple Output - 900kHz to 1MHz
- 30W - 900kHz to 1MHz
- 65W - 800kHz to 1MHz

Remote Sensing (Available On Single Output 65W Series Models Only)

Remote sense allows the user to compensate for voltage drop between the output of the converter and the point of regulation. The total voltage which may be compensated for is 0.5V in both leads (+) and (-). Make the connection to the regulation point within 1.2 meters of the converter output terminal.

To use remote sense, connect pin 3 to pin 4 and pin 6 to pin 5, otherwise the output voltage will increase.

The converter will be permanently damaged if the positive remote sense is shorted to ground. Damage may also result if the output common or positive output is disconnected from the load with the remote sense leads connected to the load.

Reverse Polarity Protection

To protect against input reverse connection, it is advised to connect a diode in series with the input pin of the converter as shown in the diagram on the previous page.

Connecting Outputs in Series

Any of the dual output converters can be configured to produce an output of 10V (+/5V output models), 24V (+/-12V output models) or 30V (+/-15V output models) by connecting the load across the output (+) with either output grounded, and leaving the common pin floating.

Heatsink Selection (65W Series Model Only)

The absolute maximum allowable case temperature is 105°C, to select a heat sink for PX30***-65 Series, the following formula for convective heat flow must be used:

$$A \approx 6.45 \cdot \left\{ \frac{\Delta T}{80P^{0.85}} \right\}^{-1.43}$$

Where: A= area of heat sink, cm²

ΔT= difference between case temperature and ambient temperature, °C

P= power dissipation, W.

INSTALLATION NOTES

1. Ensure proper connection of converter pins to the PCB following instructions of part's specification.
2. To prevent pins being stressed, causing glass insulators to crack and the module to leak, install the module with fixed flanges or screws prior to soldering the pins. Avoid bending the pins.
3. The bottom of the module should be tightly fitted to the heat sink. If necessary, thermal washers and shockproof gaskets can be employed.

px30-rev1-0915.indd

Powerstax Europe

Unit 5 Armstrong Mall
Southwood Business Park
Farnborough, Hampshire
GU14 0NR, UK

Powerstax North America

12804 W. Santa Ynez Drive
Sun City West
Arizona 85375
USA

Information and specifications contained in this data sheet are believed to be correct at the time of publication. However, Powerstax accept no responsibility for consequences arising from printing errors or inaccuracies. Specifications are subject to change without notice.